



GeoMax General Catalogue

GeoMax, part of Hexagon, provides a comprehensive portfolio for the global construction and surveying market equipment. Our systems include easy-to-use and highly-productive total stations, GNSS instruments, unique software, rotating and layout lasers, optical and digital levels, and accessories. Our portfolio is known for robustness, ease of use and outstanding software designed by and for users in construction and surveying. From our base in Europe, our technology is supported by a broad sales, support and service network covering all continents.

At GeoMax we provide a comprehensive portfolio of integrated solutions by developing, manufacturing and distributing quality construction and surveying instruments and software. We address professional as well as occasional users with our extensive portfolio of products.

Being part of Hexagon, a global leader of digital solutions, grants GeoMax access to state-of-the-art development and production facilities in Europe, North America and Asia. Our technology is supported by a broad sales and service network covering all continents and more than 100 branches. Through this continually growing distribution and service network, our products are available worldwide delivering outstanding price-performance ratio.

At GeoMax, we concentrate on providing you with the quality and functionality you need in your daily work. Removing the frills enables us to deliver products that "work when you do" – independent of weather, location and task. You get a price-to-performance ratio that you need to succeed in your tough business environment.



Content



04

TOTAL STATIONS

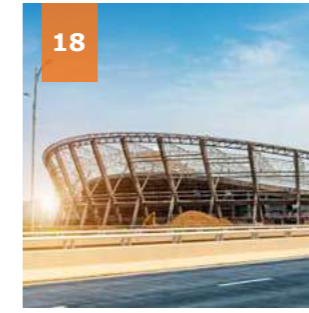

18

GNSS RECEIVERS



26

FIELD CONTROLLERS



32

SOFTWARE



40

MICRO ROBOTIC SOLUTION



44

LEVELS



48

LASER ROTATORS



54

PIPE LASERS



58

MACHINE GUIDANCE

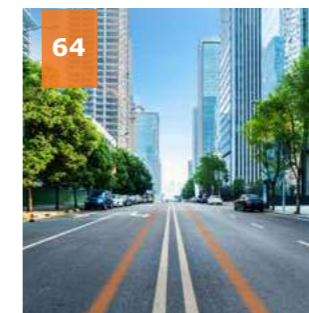

64

CABLE LOCATORS

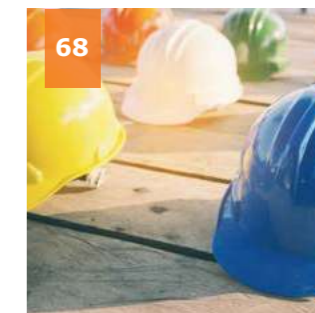

68

ACCESSORIES & QUALITY MANAGEMENT

GEOMAX TOTAL STATIONS

Boost your daily performance with these easy-to-use and highly productive total stations for a wide range of applications, such as surveying, engineering and construction.





GeoMax Zoom90 Series

The ultimate one-man system

STREAM360: FULLY ROBOTIC

Scout: Scans the entire working area within seconds to quickly find the target.

TRack: Continuously tracks targets. Once locked onto, the instrument remains accurately aimed at the moving target.

AiM: Aims accurately at any prism, without needing to look through the telescope. Measurements are performed automatically with consistently high and repeatable dependability.

X-MOTION™ HYBRID DRIVES

The GeoMax Zoom90 incorporates highly innovative X-motion hybrid drives, promoting automation performance compared to conventional drives. It will follow your target at 90km/h at 100m distance.

NAVLIGHT™

Fitted as standard in the telescope, the NavLight is an efficient alignment aid, helping to speed up work while setting out. Its flashing red and yellow lights will guide you quickly and exactly to the line of sight.

ACCXESS™ EDM TECHNOLOGY

GeoMax's accXess EDM Technology provides leading reflectorless measurements up to 1,000m.

The extra small laser footprint and the sophisticated signal-processing technology ensures accuracy, regardless of the distance or conditions.

OPEN CONNECTIVITY

Combine your preferred software and field controller to perform remote control tasks with increased productivity. Zoom90 uses the Windows CE® operating system, which enables a variety of powerful field software to run, offering you freedom to choose software that best suits your needs. Full VGA colour touch display will also provide you with superior performance and full graphic capability.

	Scout	TRack	Aim	accXess ID	accXess S
Robotic (R)	✓	✓	✓	✓	✓

TECHNICAL DATA	
Accuracy	5", 2", 1"
Prism (range, accuracy)	3500m, 1mm + 1.5ppm
Prism, long-range (range, accuracy)	10000m, 5mm + 2ppm
Non-prism (range, accuracy)	1000m/500m, 2mm + 2ppm*
Scout range	300m at round prism
TRack range	800m at round prism
AiM range	1000m at round prism



GeoMax Zoom70 Series

Your economic choice when price counts as much as performance

ONE-MAN TOTAL STATION

Equipped with the long-range Bluetooth® handle, the GeoMax Zoom70 transforms into a true one-man total station. It supports the advanced prism search, based on the GNSS position of the controller, mounted on the pole - GeoTRAIL. Due to its seamless integration into the X-PAD field software GeoTRAIL combines simplicity and high performance.

This solution convinces due to its independency of special, expensive and power-consuming active prisms. Zoom70 keeps your pole lightweight and convenient to carry all survey-day long.

FULL CONNECTIVITY

The Zoom70 meets all your connectivity needs. Use its built-in Bluetooth® for medium range data transfer or its Bluetooth® handle for high performance over long ranges. Either way, it is ideal for one-man robotic surveys.

Combine your preferred software and datalogger to perform remote control tasks with increased productivity. Zoom70 uses the Windows® CE operating system, which enables a variety of powerful field software to be run, offering you freedom to choose software that best suits your needs.

TECHNICAL DATA	
Accuracy	5", 2", 1"
Prism (range, accuracy)	3500m, 1mm + 1.5ppm
Prism, long-range (range, accuracy)	10,000m, 5mm + 2ppm
Non-prism (range, accuracy)	1,000m/500m, 2mm + 2ppm*
TRack range	800m at round prism
AiM range	1,000m at round prism

* > 500m: 4mm + 2ppm



GeoMax X-Pole

When TPS meets GNSS

WORKING SIMULTANEOUSLY WITH TPS AND GNSS

By combining the advantages of both systems, the new GeoMax X-Pole solution significantly improves performance and flexibility on the jobsite.

The seamless integration of X-Pole into the X-PAD field software allows a toggle between both measurement modes. Simply decide with the press of a button if you want to change from TPS to GNSS mode, such as when some points cannot be measured with TPS due to limited prism visibility. Once those points are measured, switch back to TPS mode.

This enhances the efficiency of the system since it eliminates the need for cumbersome and time consuming station setups. Zoom70/90's Track360 functionality enables following a moving prism. In case of loss of lock, the X-Pole solution immediately finds the pole position by obtaining the coordinates from the GNSS receiver mounted on top of the prism.

KEY FEATURES

- Simultaneous TPS and GNSS measurements during setup
- Change from TPS to GNSS measurement mode at the press of a button
- TPS and GNSS measurements stored in one common database
- Modular solution to be combined with any GeoMax GNSS receiver
- Flexible upgrade path even for robotic TPS and GNSS systems

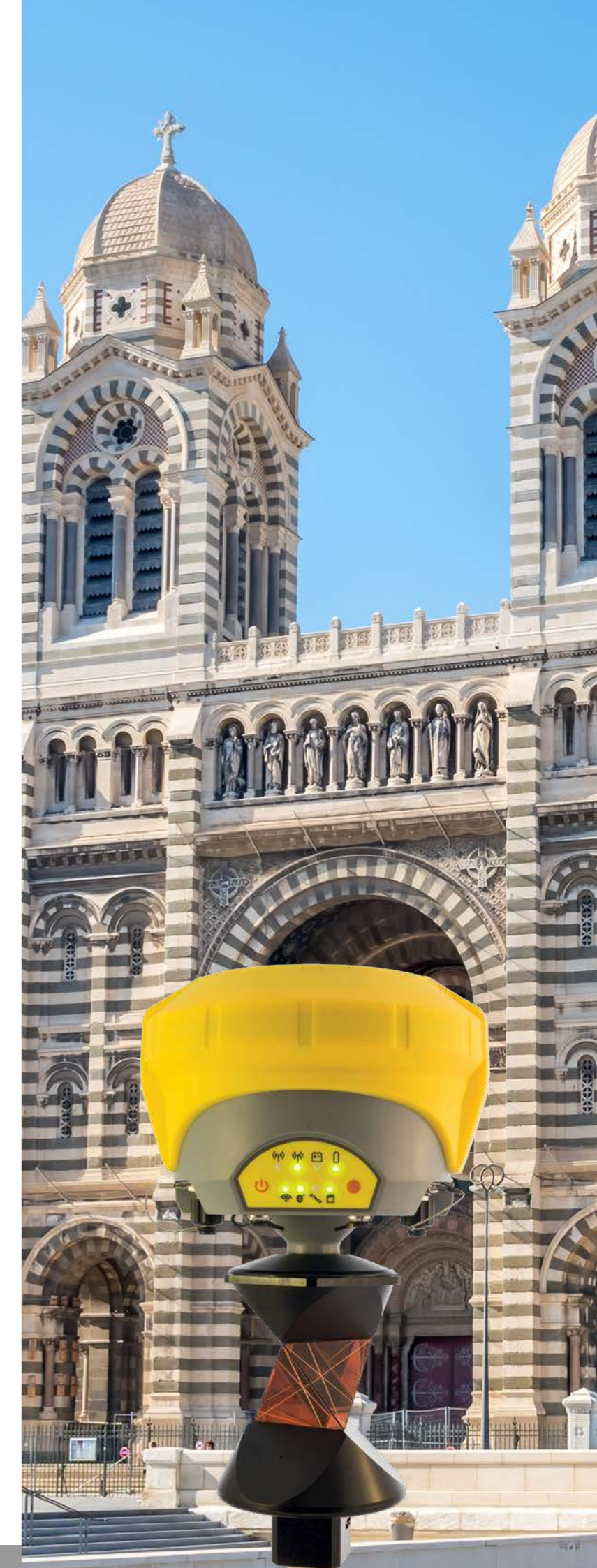

GeoMax Zoom50 Series

Highest performance on every level



SUPERIOR ACCXESS EDM

With the proven accXess technology, the GeoMax Zoom50 features an intelligent distance measurement engine designed for outstanding speed and highest accuracy even on extremely long ranges. This means a wider operational coverage and significantly less time lost with switching setups.

EASY CONNECTIVITY

The Zoom50 manual total station includes an environmentally protected USB port, internal Bluetooth® and a cable connection port. This allows for fast, simple and dependable data transfer between the instrument and your PC or handheld controller using easy-to-connect Plug and Play technology.

COLOUR TOUCH SCREEN

The extra-large 3.5" colour touch screen with Q-VGA display provides for brilliant readability even in strong sunlight. Together with an extra-large high-resolution display, the easy-to-use graphical interface makes regular tasks, such as stake-outs, easier and more productive than ever before.

TECHNICAL DATA

H _z , V Standard deviation (ISO 17123-3)	1", 2", 5"
Compensator system	Quadruple-axis compensation
Measuring range with prism	10,000m
Accuracy on reflector (Fine/Tracking)	2 mm + 2ppm/3mm + 2ppm
Reflectorless range accXess5	>500m
Reflectorless range accXess10	>1,000m
Accuracy reflectorless	2mm + 2ppm (>500m 4mm + 2ppm)
Communication	USB, Bluetooth®, USB Host, RS232

GeoMax Zoom50 accXess5

Distance measurement to reflector and 500m reflectorless.

GeoMax Zoom50 accXess10

Distance measurement to reflector and 1,000m reflectorless.

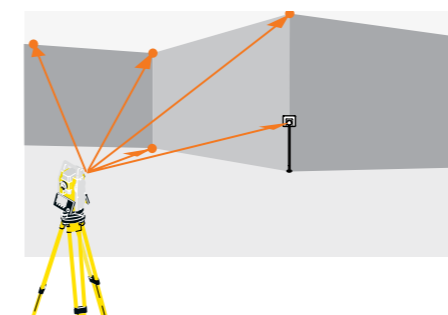

APPLICATIONS

Your Zoom50 total station comes with a complete range of powerful applications:

- Survey and coding
- Set-up with resection
- Set out
- Area 3D and volume
- Remote elevation
- Construction
- Reference line
- Reference arc
- Grid setout
- Column offset
- CoGo routines
- Missing line measurement
- Two prism offsets
- Road 2D
- Road 3D
- Traverse with on board adjustment

GeoMax Zoom40 Series

Fully open Windows CE® to operate the field software of your choice

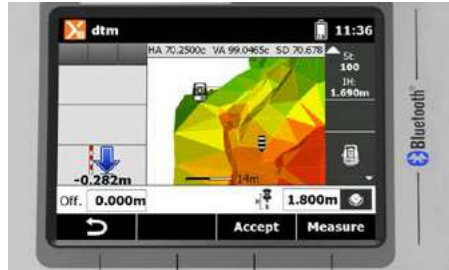

TOTALLY OPEN WINCE®

The GeoMax Zoom40 is a fully open WinCE® total station. Featuring X-PAD, GeoMax FieldGenius, Carlson SurvCE or any localised field software, the Zoom40 allows you to work as best fits your needs. WinCE® even allows you to run your own developments and to personalise your system.

COLOUR TOUCH SCREEN

The extra-large 3.5" Q-VGA high resolution colour and touch screen display provides brilliant readability even in strong sunlight. Together with an easy-to-use graphical interface, it makes the regular tasks, like stake-outs, easier and more productive than ever before.

FULLY FEATURED

All the openness and connectivity combined with a system offering a colour and touch display, neXus5, the long range non-prism measurement, and all your favourite Windows CE® applications make the Zoom40 the total station that "works when you do."

TECHNICAL DATA

Hz, V Standard deviation (ISO 17123-3)	2", 5"
Compensator system	Quadruple-axis compensation
Measuring range with prism	3,500m
Accuracy on reflector (Fine/Tracking)	2mm + 2ppm/3mm + 2ppm
Reflectorless range neXus5	500m
Accuracy reflectorless	2mm + 2ppm
Communication	USB, Bluetooth®, USB Host, RS232

GeoMax Zoom40 neXus5

Distance measurement to reflector and 500m reflectorless.



X-PAD





GeoMax Zoom25 Series

If you don't want to compromise on quality



ON BOARD SOFTWARE

Easily control your data with the flexible and easy-to-use on board software. Areas and volumes, reference elements, CoGo and more can be accessed using the large graphic display. Import and export in the format you want for total control and flexibility.

NEXUS™ EDM TECHNOLOGY

Geomax's neXus5 EDM technology delivers high dependability and class-leading accuracy with and without a prism under difficult conditions. Reflectorless neXus5 EDM technology supports measurement ranges up to 500m.

BUILT FOR ALL ENVIRONMENTS

The GeoMax Zoom25 Series withstands the toughest environments. With the optional polar certification, the Zoom is individually tested at -30°C. With our extensive factory tests, you can be sure that GeoMax "works when you do."

TECHNICAL DATA

Hz, V Standard deviation (ISO 17123-3)	2", 5"
Compensator system	Quadruple-axis compensation
Measuring range with prism	3,500m
Accuracy on reflector (Fine/Tracking)	2mm + 2ppm/3mm + 2ppm
Reflectorless range neXus5	500m
Accuracy reflectorless	2mm + 2ppm
Communication	USB, Bluetooth®, USB Host, RS232

GEOMAX ZOOM25 NEXUS5

Distance measurement to reflector and 500m reflectorless.



X-PAD

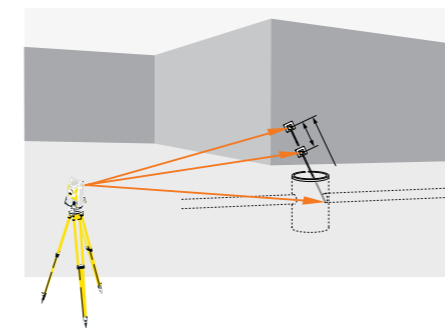

POWERFUL APPS

Every Zoom25 series instrument comes with a complete range of powerful applications:

- Survey and coding
- Set-up with resection
- Set out
- Area 3D and volume
- Remote elevation
- Construction
- Reference line
- Reference arc
- Grid setout
- Column offset
- CoGo routines
- Missing line measurement
- Two prism offsets
- Road 2D

GeoMax Zipp10 Pro Series

Your economic choice when price counts as much as performance

EASY CONNECTIVITY

The GeoMax Zipp10 Pro features a simple transfer using a USB stick of all your data and files. Transferring data between different total stations or the office is now easier than ever and liberates you from the need to use any PC.

PERFORMANCE, ROBUSTNESS

Providing a 250m reflectorless measurement range, a long prism range of 3,000m, a coaxial visible laser beam combined with a dust, and water resistant sealed durable housing makes the Zipp10 Pro a top performer in its class.

MULTIFUNCTIONAL KEYBOARD

With an ergonomic full numeric keypad for rapid navigation and data entry provides for direct access to apps and fast navigation. The large high-resolution bright display provides brilliant readability even in strong sunlight.

APPLICATIONS

Every Zipp10 Pro series instrument comes with a complete range of powerful applications:

- Data collect and coding
- Set out
- Resection
- Area and volume
- Remote elevation
- Reference Line
- Missing line
- Road

TECHNICAL DATA	
Hz, V Standard deviation (ISO 17123-3)	2", 5"
Range with prism	3,000m
Non-prism range	250m
Accuracy with prism	2mm + 2ppm
Non-prism accuracy	3mm + 2ppm
Measuring time (tracking/quick/fine)	0.33sec/2.0sec/2.4sec
Reflectorless measuring time	3.0 – 6.0sec

GEOMAX ZIPP10 R2

Distance measurement on reflector 250m non-prism distance.



GeoMax Zipp02

Digital theodolite for all your general construction tasks

CLOSING THE GAP

With vertical compensation and 2" accuracy, the GeoMax Zipp02 provides you with the precision required for your most demanding jobs at an affordable price without adding complexity. Various display modes, the ability to hold and set zero for horizontal angle, a variation of measurement units, and simple distance measurement via stadia lines all make for easy operation with only six keys. Visible laser plummet enables you to set up over a point faster and easier than ever. The Zipp02 is the tool of your choice when it comes to checking angles, alignments, grade work and short-range levelling.

TECHNICAL DATA	
Precision	2"
Magnification	30x
Compensator system	Automatic vertical compensator User set on/off
Display	Double side large character back-lit LCD
Keypad	Numeric with 3 programmable function
Keys	6 one-touch button functions
Operation period w/o laser plummet	36h

GEOMAX GNSS RECEIVERS

Ensure ultimate reliability with GeoMax GNSS systems under the most severe conditions. Providing true cost-effectiveness, these systems are equipped with the latest GNSS technology in the field to increase your productivity and taking your performance to the new level.



GeoMax Zenith35 Pro Series

Full spectrum of satellite signals, unlimited connectivity and Tilt&Go functionality



FULL CONNECTIVITY

- Access from any device connected to the internet, independent of your location
- Connect up to 10 rovers simultaneously via GSM with Zenith35 Pro DynDNS technology
- 3.75G GSM for NTRIP connections
- Powerful UHF for base-rover setups
- USB port for data transfer
- Serial port for data output



FULL SKY

- 555 channels multi constellation and multi frequency, ready for all today's and tomorrow's GNSS systems, including Galileo and BeiDou.
- NovAtel® on board - Cutting-edge GNSS technology
- Zenith35 Pro ExtraSafe mode - Working under heavy canopy or when most reliable results are required, this feature adapts to different working conditions.

FULL FREEDOM

A corner of a building or even a gully under a parked car? The unique GeoMax Zenith35 Pro Tilt&Go (TAG) functionality allows you to measure points where a vertical placement of the pole is not possible, such as house corners.

No longer worry about keeping your pole strictly vertical, just Tilt&Go! Seamlessly integrated into the field software, the Zenith35 Pro TAG offers two modes perfectly adapting to the measurement situation.

- TAG Single - Measure points with pole tilted up to 15° with only a press of a button.
- TAG Dual - Measure points with the pole tilted up to 30° independent from magnetic field discrepancies.

TECHNICAL DATA	
AdVance® technology	High fix availability + reliability
Channels	555, multi-frequency
Satellite signals	GPS L1,L2,L2C,L5; GLONASS L1,L2,L3*;BeiDuB1,B2,B3** Galileo E1,E5a,E5b, AltBOC,E6***; EGNOS;WAAS,MSAS,GAGAN, QZSS****
Positioning rate	5Hz, 20Hz****
Accuracy static H/V	3mm ± 0.5ppm (rms)/ 5mm ± 0.5 ppm (rms)
Accuracy kinematic H/V	8mm ± 1ppm (rms)/ 15mm ± 1ppm (rms)

*Glonass L3 will be provided through future firmware upgrade.
 **Believe to comply. Subject to ICD description availability. The position accuracies depend on various factors including the number of satellites, geometry, ionospheric, conditions, multipath, etc
 ***Support of QZSS is incorporated and will be provided through future firmware upgrade when QZSS will be operational.
 ****Optional for Zenith35 Pro GSM-UHF-TAG



X-PAD

GeoMax Zenith15/25 Pro Series

Built to last, built for the future



EXTREMELY RUGGED

The GeoMax Zenith15/25 Pro GNSS series provides IP68 dust- and waterproofness, enabling use even in extreme environments. The system is robust enough to withstand a 2m topple over and a complete submersion under water.

NOVATEL® ON BOARD

Equipped with Measurement Engines from NovAtel®, a leading provider of high precision GNSS, Zenith15 and Zenith25 Pro receivers provide the maximum performance.

Q-LOCK™ TECHNOLOGY

The Q-Lock™ technology tracks all satellites with the highest available signal strength and performs regular independent checks to ensure that you can work even in challenging environments such as urban canyons or under heavy foliage.

TECHNICAL DATA	
Q-Lock™ technology	Lowest noise and multipath mitigation
Channels	120, dual frequency
Satellite signals	GPS, GLONASS BeiDou*; Galileo**; SBAS
Positioning rate	5Hz, 20Hz**
Accuracy static H/V	Zenith25 Pro: 3mm ± 0.5ppm (rms)/5mm ± 0.5ppm (rms) Zenith15: 5mm ± 0.5ppm (rms)/10mm ± 0.5ppm
Accuracy kinematic H/V	Zenith25 Pro: 8mm ± 1ppm (rms)/15mm ± 1ppm (rms) Zenith15: 10mm ± 1ppm (rms)/20mm ± 1ppm (rms)

Measurement accuracy and reliability are dependent on various factors including satellite, geometry, obstructions, observation time, ionospheric conditions, multipath, etc. Figures quoted assume normal to favourable conditions.

*Opt. for Zenith25 Pro Incl. in Zenith25 Pro⁴

**Opt. for all Zenith25 Pro



X-PAD

GeoMax PicPoint

Your contactless GNSS system



GEOMAX PICPOINT

With GeoMax PicPoint you can easily measure points directly in the field that cannot be measured with conventional GNSS measurements, such as on façade points or objects with restricted access possibility.

PicPoint combines GNSS measurements with images taken from the camera attached to the pole. The innovative X-PAD field software running on an Android™ tablet uses photogrammetric principles to enable a point determination, CAD drawings and various COGO calculations, such as Area and Tie Distance. Of course, measured points are visualised in the image allowing a visual completeness check of your survey directly on site. And if you should ever have missed to measure some points, this can be done easily in the office.

In all the listed situations, the PicPoint is a practical, fast and accurate solution that can be combined with any receiver of the GeoMax GNSS portfolio.

KEY SPECIFICATIONS:

- Range: up to 25m
- Accuracy: Relative 5mm/ Absolute: 5cm
- Resolution: up to 18MP
- Battery: up to 350 images
- Water- and Shockproof
- Weight: 160g

GeoMax GNSS antennas

	ZENITH15	ZENITH25 PRO	ZENITH25PRO ⁴	ZENITH35 PRO	ZENITH35 PRO TAG
Measurement Engine					
Channels	120			555	
GPS tracking	L1, L2, L2C			L1, L2, L2C, L5	
GLONASS tracking	L1, L2			L1, L2, L3*	
BeiDou tracking	-	B1 opt.	B1,B2	B1, B2, B3**	
Galileo tracking	-	E1 opt.	E1, E5b opt.	E1, E5a,E5b, AltBOC, E6**	
Positioning rate	5Hz	5Hz 20Hz opt.	5Hz 20Hz opt.	5Hz	5Hz, 20Hz opt.
SBAS	EGNOS, WAAS, MSAS, GAGAN			EGNOS, WAAS, MSAS, GAGAN, QZSS***	
Tilt&Go					
Single/Dual Mode	-			-	Yes
ACCURACY**					
Static H/V (mm + ppm)	5 + 0.5/10 + 0.5	3 + 0.5/5 + 0.5		3 + 0.5/5 + 0.5	
Kinematic H/V (mm + ppm)	10 + 1/20 + 1	8 + 1/15 + 1		8 + 1/15 + 1	
Static long H/V (mm + ppm)	3 + 0.1/3.5 + 0.4	3 + 0.1/3.5 + 0.4		3 + 0.1/ 3.5 + 0.4	
COMMUNICATION					
GSM/GPRS module	3.75G			3.75G	
UHF radio module	Optional	Optional	Included	500mW, 1000mW; selectable Included	
Bluetooth®	Yes			Yes	
WiFi	-			Yes	
Remote Configuration via DynDNS	-			Yes	
Communication port	USB, serial and power			USB, serial and power	
INTERFACES					
Data recording	Removable microSD card			Removable microSD card and 4 GB internal memory	
GSM/TCP/IP	Removable SIM card			Removable SIM card	
PicPoint support	Yes			Yes	
X-Pole support	Yes			Yes	
POWER SUPPLY					
Operating time (static/rover)	7.5h/5h	9h/6h	9h/6h	8h/6h	
PHYSICAL SPECIFICATIONS					
Dimensions/Weight	1.07kg without battery			1.17kg without battery	
Operating temperature	-40°C to 65°C			-40°C to 65°C	
Protection class	IP68			IP68	
Humidity	100%, condensing			100%, condensing	
Vibration	Mechanical stress resistant according ISO 9022-36-05			ASAE EP455 Section 5.15.1 Random, MIL-STD-810G, method 514.6E-1	
Shock	Withstands 2m topple over onto hard surface			Withstands 2 m drop onto hard surface	
Warranty					
Standard Warranty	1 year			1 year	
Extendable warranty	-	Yes	Yes	Yes	

* Glonass L3 will be provided through future firmware upgrade.

** Believe to comply. Subject to ICD description availability.

*** Support of QZSS is incorporated and will be provided through future firmware upgrade when QZSS will be operational.



GEOMAX FIELD CONTROLLERS

Based on an open platform, just use the software that best fits your requirements and rely on the robustness and precision of these easy-to-use devices.

GeoMax Zenius5 W

Versatile field controller



FULLY FEATURED, FULL FLEXIBILITY

The GeoMax Zenius5 W is a versatile handheld fully packed with everything needed to do the job. If you are looking

for flexibility in software and versatility in handling connections to hardware in the field or in the office, this unit is for you.

The on board 5MP camera helps with daily documentation tasks by taking

photos and storing them as notes. This rugged field Windows Mobile® handheld is built to meet GeoMax requirements for power, functionality and reliability, ensuring they always “work when you do.”



TECHNICAL DATA	
Channels	72 channel u-Blox
Satellite signals tracked	GPS, GLONASS, BeiDou, Galileo; single frequency
RTK accuracy	2.5m CEP (Auto.)/2.0m CEP (SBAS)
SBAS	WAAS/EGNOS/MSAS/GAGAN
Operating system	Windows® embedded handheld 6.5 Professional
Memory	512MB program memory, 8GB storage capacity, MicroSD card slot

TECHNICAL DATA	
USB	Mini waterproof USB connector
Wireless	Integrated quad-band GSM/GPRS, phone function
Bluetooth®	Bluetooth® V2.1 support EDR
Wi-Fi	802.11 a/b/n Wireless LAN
Cellular	3.75G cellular modem
Camera	AutoFocus 5MP
Power	up to 10 hours

GeoMax Zenius8

Rugged Windows Mobile® & Android™ field controller



POWERFULL AND ROBUST

The GeoMax Zenius8 is a premium class field controller with unmatched user friendliness, class-leading performance, and the highest flexibility and ruggedness.

Due to its capability to mount a high performance long range Bluetooth® cap, it is the ideal device to control the GeoMax Zoom90 robotic total station in one-man operation.

The unique flexibility in choosing the operating system, combined with

unmatched performance and outstanding robustness, makes the Zenius8 field controller of choice. It's performance without compromising quality.

KEY FEATURES:

- Flexible operating system concept
 - Windows® embedded handheld 6.5 professional
 - Android™ 4.2.2
- GeoMax customised operating system, for perfect match with GeoMax software and hardware
- 4.7" wide VGA display

- 8 megapixel camera for geo-tagged site documentation
- Large memory - 1GB RAM, 4GB storage
- MicroSD card support
- RS232, USB, Bluetooth® and Wi-Fi connectivity for maximum flexibility
- Inbuilt 56 channels multi constellation GNSS
- Light weight – 490g including battery
- Rugged
 - IP67 dust and waterproof
 - Vibration resistant according MIL standard

TECHNICAL DATA	
Processor	Texas Instruments 4470 dual-core @ 1.5GHz
Memory/Disk	1GB RAM/4GB iNAND Flash
Operating System	Windows® embedded handheld 6.5.3; Android™ 4.2.2
Screen	4.7" FWVGA (854x480); IPS; 600nits, capacitive multi-touch Asahi Dragontrail chemically strengthened glass
Keypad	Numeric with 3 programmable function keys
Battery	Li-Ion, 3.7V 5200mAh (19.2Wh) (Hot-swappable) with smart gauge
Communication	Audio: Built in: Receiver, loud-speaker; mic BT: Class 2 (10m), v3.0 in Android™ OS and v2.0 in Windows Mobile® OS Wireless LAN: 802.11 b/g/n
Navigation	Integrated with stand-alone u-Blox® GPS
Camera	8-megapixel rear-facing camera with autofocus and LED illumination

GeoMax Field Controllers

	ZENIUS5 W	ZENIUS8
Primary use case	GNSS	Robotic TPS
Processor Speed	1GHz	1.5GHz
Operating system	Windows Mobile®	Windows Mobile® & Android™
Screen size	3.7"	4.7"
USB Host port	Via Adapter	Yes
Camera resolution	5MP	8MP
Camera flash	-	Yes
Hot swappable batteries	-	Yes
Env. Protection (IP)	65	67
Rain/wet mode	-	Yes
Weight (incl. battery)	575g	490g
Int. Memory - RAM	512MB	1GB
Int. Memory - Storage	8GB	4GB
Battery lifetime	8.5h	7.5h
Smart battery	Yes	-
GSM	3.75G	-
GNSS channels	72	56
Max. Bluetooth® range*	Up to 800m	> 600m (with LRBT cap)
GNSS constellations	GPS/GLO/BD	GPS/GLO/SBAS/QZSS
Warranty	1 year	1 year

* Optimal conditions, free line of sight



GeoMax FZ-M1 & Zenius700 A

Fully rugged tablets to support the most severe weather conditions



CONNECTIVITY AND PERFORMANCE

Resistant to challenging working conditions with extreme performance thanks to flexible configurations, Bluetooth® and WiFi connectivity, and a powerful processor.

DESIGNED FOR PROFESSIONALS

Their ergonomic and lightweight design naturally fits into your hands, and once there, the Windows® 8.1 for FZ-M1 or Android™ 6.0 for the GeoMax Zenius700 A functionality will boost your performance no matter the challenge you face.

FULLY RUGGED

These tablets do not need to hide outdoors. Their multi-touch and sunlight-viewable screen allows you to interact with it without even taking off your gloves. And because accidents in the field can happen, these tablets are also shock resistant and water and dust proof.

	FZ-M1	ZENIUS700 A
Mobile computing platform	Intel Celeron®. N2807 processor 1.58GHz 1MB L2 Cache	Intel® Atom™ Processor; up to 1.92GHz
Operating system	Windows® 8.1 Pro	Android™ 6.0
RAM	2GB	4GB
Camera	2 MP front/5MP rear	2MP front/8MP rear
Features	WiFi, Bluetooth® 4.0, 4G LTE, USB, GPS external antenna connector	WiFi, Bluetooth®, Inbuilt GPS, 4G LTE modem, Micro-USB/USB Host, MicroSD Card slot
Display	7" sunlight-viewable WXGA Active Matrix (TFT) IPS LCD with circular polariser (up to 500cd/m brightness); multi-touchscreen	Extra-large 7" HD display (1280x720), with high sunlight readability and glove proof operation



GEOMAX SOFTWARE

All GeoMax software is developed to make your daily work more easy and flexible. Highly innovative content as well as simple and intuitive interactions with the system.

GeoMax X-PAD Ultimate

The Ultimate solution in the field

X-PAD Ultimate is a tailored, flexible, modular, ideal, customised software for high end topographic tasks, such as measure, stakeout, cadastral, BIM check and control, roading, mapping, bathymetry and GIS. Running on Android, it brings the best technologies to topography.

X-PAD Ultimate ensures productivity in the field and provides perfect integration between measure tools. Available in two versions, one dedicated to the professional surveyors and one dedicated to the construction company, offers to both a specific working environment and a set of dedicated features.

TOPOGRAPHIC 3D CAD

X-PAD Ultimate includes a real topographic 3D CAD, not just a simple graphic viewer, with specific functions to draw, edit, measure and calculate the position of new elements that can be then used in stakeout operations.

MAPS, WMS AND OFF-LINE

X-PAD Ultimate allows you to use different types of standard maps but also Web Map Service (WMS) maps; off-line mode is also supported.

DATA COLLECTIONS. NOT ONLY COORDINATES

Measuring the position of the points is the main purpose to use the topographic equipment, but with X-PAD Ultimate you go further because you can integrate the position, photos and notes.

Quick Codes allow you to create your own custom panels with the most used codes and measure the position of the point automatically just after you choose the code.

STAKEOUT... WITH YOUR EYES CLOSED

With X-PAD Ultimate, stakeout has never been easier or faster. Voice guidance allows you to arrive at the point without even looking at the display while the large compass simplifies visual navigation. Every drawing element, including points, lines, arcs and every position is determined within the graphical view can be staked out.

X-POLE: ONE POLE, TWO SYSTEMS

The X-Pole solution allows you to work simultaneously with TPS and GNSS using the best features of each system and with maximum flexibility. A simple click is all you need to change the measurement mode and switch from GNSS to TPS mode and vice versa. The GNSS system positioned above the prism, gives you a direct rotation on the prism speeding up the locking operations after loss.

AUGMENTED REALITY. TURN ON REALITY!

Point the camera to the site and you can see immediately where the points and elements are for stakeout. X-PAD Ultimate will guide you in the vicinity of the point and then determine the exact location, but you can also use augmented reality to see what is not possible to see.

TERRAIN SURFACES AND VOLUMES

With the Volumes features, X-PAD Ultimate can calculate terrain models from the points with the options to define breaklines and boundaries. From the models, you can go to the volume calculation to determine at a glance the cubic metres of an excavation or of a pit. You can also import models from DXF or LandXML files. Use the stakeout command to determine, in field, the design elevations.

BIM

With BIM, IFC files can be loaded, displayed in the main CAD view and also in survey, stakeout and COGO commands. Elements can be selected, hidden or isolated. From BIM models, it is possible to extract points, lines, surfaces and cross-sections for stakeout and checking operations.

CLOUD AND SHARING POINT. FIELD AND OFFICE, ALWAYS CONNECTED

With X-PAD Ultimate you can open and import any file, even if it is in the cloud. You can save your data on the most popular cloud platforms, like Google Drive, Microsoft OneDrive and Dropbox, and access from the field or office. If you need to, though, you can also share information and coordinates of the measured points quickly via a message or email with photo attached to those in the office waiting for the coordinates of a point.

ROADING. THE WHOLE PROJECT IN THE CONTROLLER

The Roding feature allows you to load, manage and perform alignment stakeouts of works such as roads, highways and canals. The management is fully visual, so you always know what you're doing. At any moment, you can see plans, vertical profiles and cross sections.

You can stake all elements of the work (axes, edges, sideslopes, walls, ditches) at any station and with any offset, using the cross sections, the edge polylines or by defining one or more sections template.



Survey

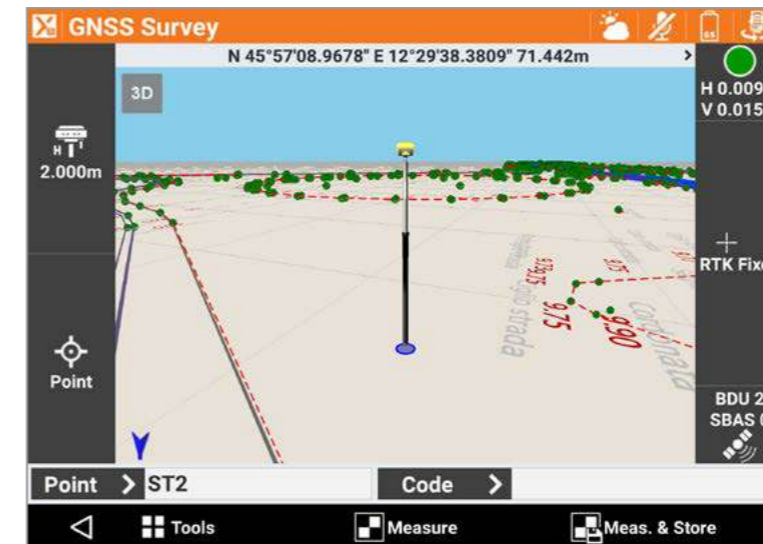

X-PAD Ultimate Survey is the best solution for professional surveyors that want accuracy, complete features, flexibility, data integration, scalability and the latest technologies in the field. With a set of different modules, X-PAD Ultimate Survey covers all the needs in the field using TPS and GNSS measure tools.

Build

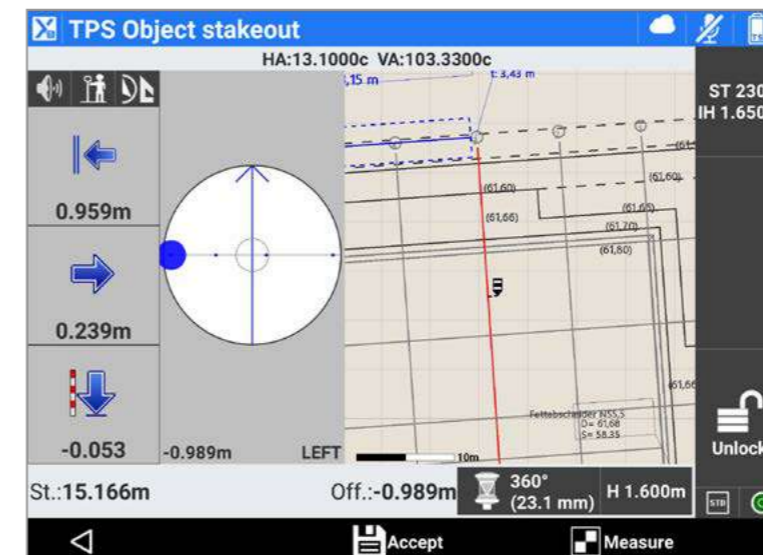

X-PAD Ultimate Build is the ideal solution for all your construction measuring and layout needs - executing all construction activities in an efficient and productive way. It combines data collection from TPS or GNSS, allowing you to perform the measurement, stakeout and as-built with simple and functional procedures. Continuous improvements and developments are made working closely with users in the field.

X-PAD Ultimate Build is a special and tailored version of X-PAD Ultimate Survey, from which inherits all the main features and functionalities, but differs because it is specifically addressed to construction companies that can solve all measuring situations onsite in an autonomous and independent way, improving productivity and reducing costs. To use X-PAD Ultimate Build you don't need to be a surveyor; all procedures are guided and can also be used by those who use this type of equipment for the first time.

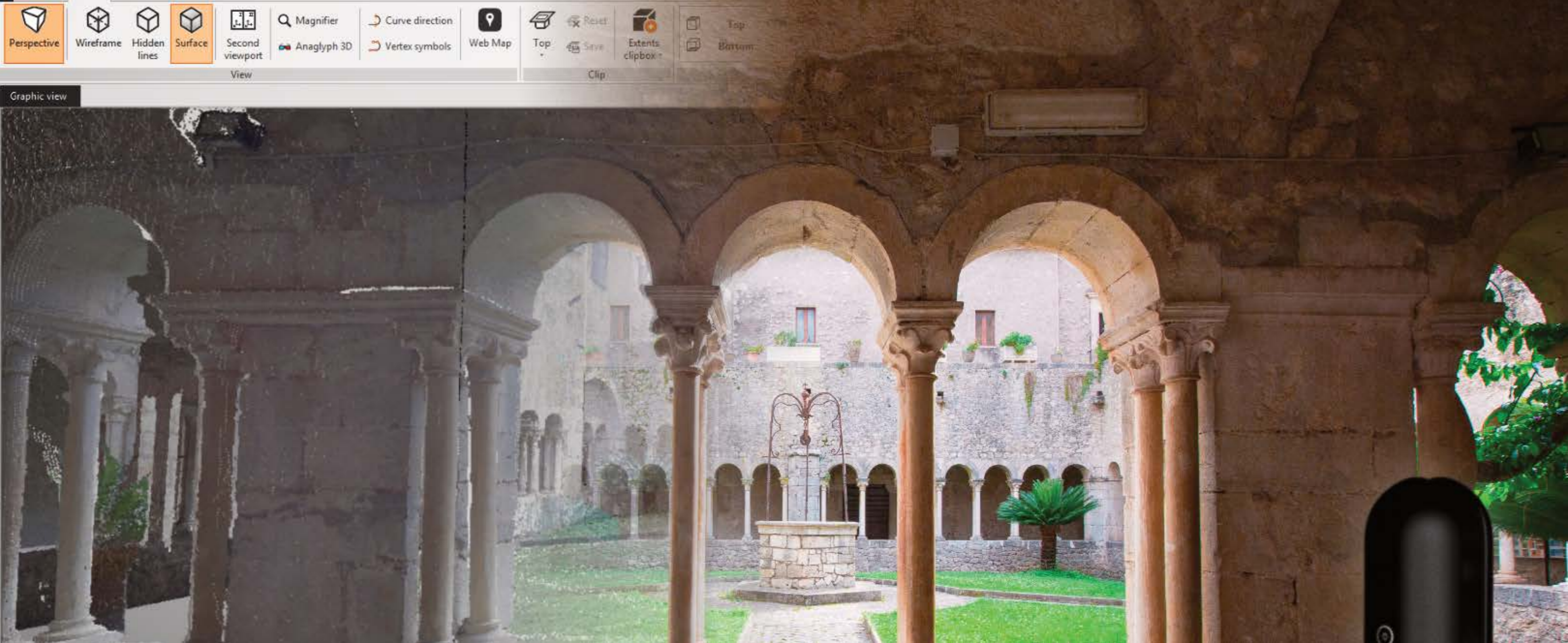

GeoMax X-PAD Office Fusion

The geospatial data office software

GeoMax X-PAD Office Fusion is a new concept with real integration of different information. Experience easy import of data, calculations, adjustments, scan registration and management of the clouds, points, measures, surfaces, BIM models, drawing and images, topographical utilities, and drawing functions - all in one.

X-TOPO: THE TOPOGRAPHIC MODULE

X-TOPO module allows to import the measurements from your instruments and have the full control of all the information to verify at any time the quality of your work; it calculates and solves all kinds of surveys, GNSS, total station, digital level and mixed with the least squared algorithms for precise calculation.

From topographic points or point clouds it is possible to create 3D models, contour lines, calculate cross-sections and volumes using several methods. Powerful tools and options allow you to customize the final drawings to obtain the best results possible for you customers.

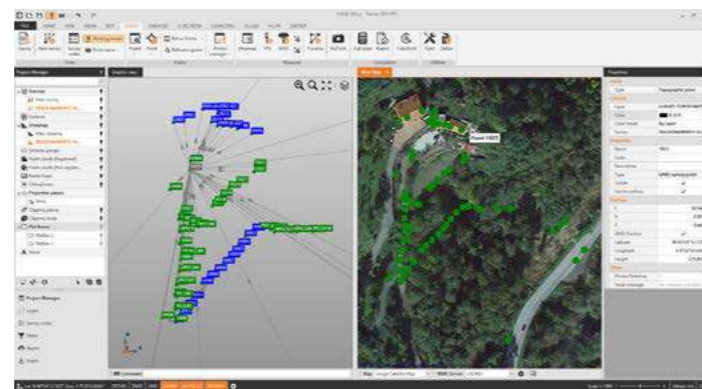

BIM CONNECT MODULE

Load and manage IFC files, extract elements for stake-out, and check as-built data with field measurements in the most efficient way.

X-SCAN: THE POINT CLOUDS MODULE

X-SCAN module allows to manage your point clouds data; robust algorithms are able to process point clouds and return the best results considering all the scans as a whole. Several options allow to improve the results according to the specific type of work and target recognition offers another way to have faster and better results. The automatic registration module is an irreplaceable tool that generate the final results with one single click. Orthophoto, cross-sections and surfaces can be generated them with very few and intuitive steps.

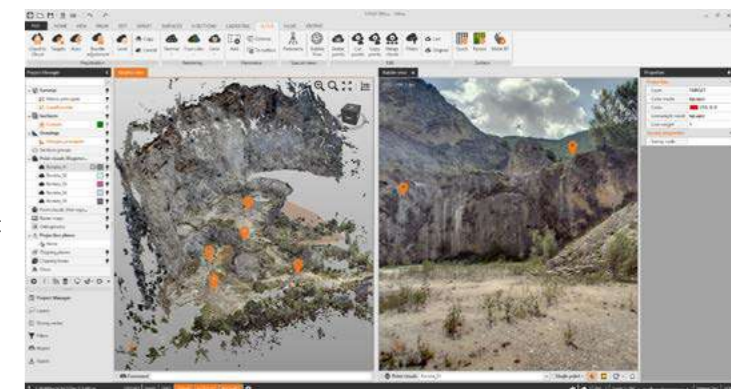

GeoMax X-PAD CalMaster

Efficient calibration for all your lasers



NEW BUSINESS OPPORTUNITIES

The GeoMax X-PAD CalMaster enables you to offer the complete construction laser package to customers and solidify your professional reputation. Opening new value-added streams of service revenue, you can significantly reduce downtime with your own in-house calibration capability.

MAKE LIFE EASIER

Laser calibrations have never been that easy and fast to do. X-PAD CalMaster users can reduce their calibration time significantly by using the system for the construction tools laser calibration. It enables a highly accurate method to calibrate lasers and can be operated without extensive training needed.

COMPLETE THE SYSTEM

The system runs on a X-PAD software that is well-known in the market for its user-friendliness and intuitive interface. Holding its promise, the X-PAD software guides users step-by-step through the measuring workflow and supports them with instructions for accurate and fast measurements.



GEOMAX ZONE SERIES



GEOMAX PIPE LASERS



3RD PARTY LASERS



3RD PARTY PIPE LASERS



3RD PARTY LINE/ POINT LASERS

	GEOMAX ZONE SERIES	GEOMAX PIPE LASERS	3RD PARTY LASERS	3RD PARTY PIPE LASERS	3RD PARTY LINE/ POINT LASERS
Issue calibration report	✓	✓	✓	✓	✓
Check plane laser beam	✓		✓		✓
Check spot beam	✓	✓	✓	✓	✓
Check grade 0.5%	✓		✓		
Check grade 1.0%	✓	✓	✓	✓	
Check grade 1.5%	✓		✓		
Guided calibration	✓	✓			
Live mode	✓	✓	✓	✓	✓

(including red, green and infrared lasers)

GeoMax Geo Office (GGO)

The ideal companion for your GeoMax equipment

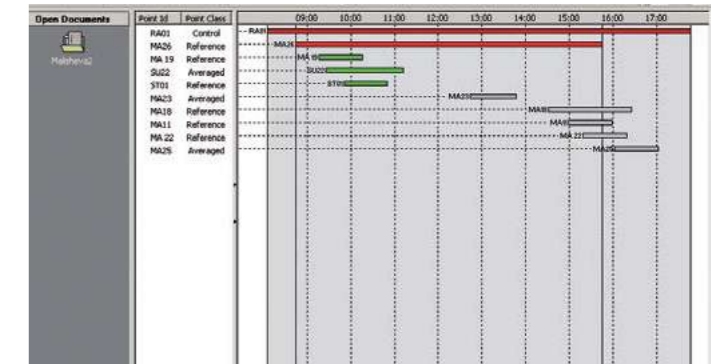
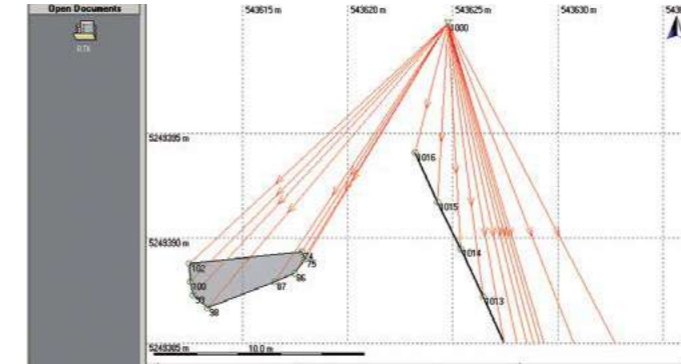

EASY-TO-USE

Following Microsoft Windows® standards, GeoMax Geo Office (GGO) is easy to use, even for novice PC users. Through the use of icons and graphics working with data in GGO is as easy as point and click.

RINEX IMPORT/EXPORT

Support of GNSS processing using multiple sensor brands is assured thanks the GGO's RINEX Import/Export option. By using the industry standard RINEX format you can import third party receiver data and post-process in GGO.

PREPARE, VISUALISE, EDIT

GGO has a full suite of tools that allow you to get the most out of your equipment before going on-site. Once you've completed your survey and seamlessly imported your field results into GGO, all observations are immediately available for visual confirmation of field activities. If errors or changes are found, they can be easily edited to deliver perfect results.

DATA PROCESSING AND REPORTING

When post-processing of GNSS data is required, GGO provides state-of-the-art technology to guarantee you always produce optimal results. Simply import data, and GGO will automatically process all possible GNSS baselines. Once results are available, they can be presented in customised reports.

LEAST SQUARES ADJUSTMENT

A rigorous 3D least squares adjustment package is available. This option allows the adjustment using least squares of GNSS, total station and combined data by using a variety of different parameters and coordinate systems. The results are stored in well-designed HTML report.

GeoMax FieldGenius Premium

Powerful field software for all your daily surveying tasks

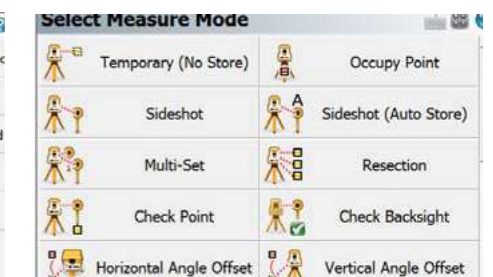
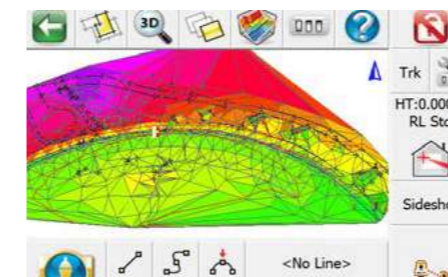

DIGITAL TERRAIN MODELING, VOLUMES AND CONTOURING

FieldGenius has the ability to create and utilise DTM surfaces from existing survey data or create a DTM in real time as the data is collected. The TIN and contours will automatically update with each new shot.

POWERFUL ROADING

FieldGenius roading allows you to manually input or import your alignment data including centre line, vertical and template data. Stake your points along your alignment with confidence.

INSTRUMENT CONTROL AT YOUR FINGERTIPS

Total station and GPS functions are available on a common and easy-to-use instrument toolbar. Access measuring modes with the click of a button.

GEOMAX MICRO ROBOTIC SOLUTION WITH MASTERPLAN

The GeoMax Zoom3D and X-PAD MasterPlan software are your perfect partner for measurement and layout applications, indoors and outdoors.



GeoMax Zoom3D

Micro Robotic Solution with MasterPlan



Measurements and layout have never been so easy and fast. With an easy set-up, the intuitive GeoMax X-PAD MasterPlan Android™ software and one-man operation, the Zoom3D will speed up your daily work indoors and outdoors and bring the plan into the field.

X-PAD AND ZOOM3D - YOUR PERFECT SYSTEM

X-PAD is known for its user-friendliness and it's easy setup. X-PAD MasterPlan has been specifically designed to make the work with the Zoom3D as easy as possible and help professionals to modernise their business and improve their workflow efficiency.

With just a few steps, you are ready to measure. No matter if in dark or sunlight conditions, targeting on hidden points, or over short or long distances up to 50m, the Zoom3D offers many intelligent features to precisely target the aimed point.

By pressing one key, the point is measured and visualised on your screen.

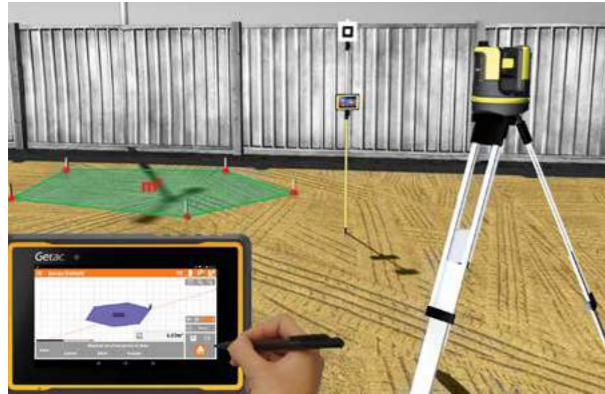

ONE-MAN LAYOUT

Increase your efficiency and increase productivity in your daily work. X-PAD MasterPlan includes an easy-to-use but powerful stakeout tool for the site layout. With the Zoom3D target recognition technology, you can measure and stake out using a pole by one person.

Easy levelling, plumbing points and staking out - the Zoom3D unique and user-friendly on board software comes with a full set of features that will speed up your outdoor and indoor applications.

AS-BUILT AND DRAWING IN ONE STEP

X-PAD MasterPlan features a full range of drawing tools. These features allow you to draw the 3D environment quickly and easily by using the Zoom3D's drawing function. The results can be exported in DXF or ASCII format. Draw 2D and 3D elements with the best results using the X-PAD MasterPlan. Get fast and exact results and all at the best price-to-performance.

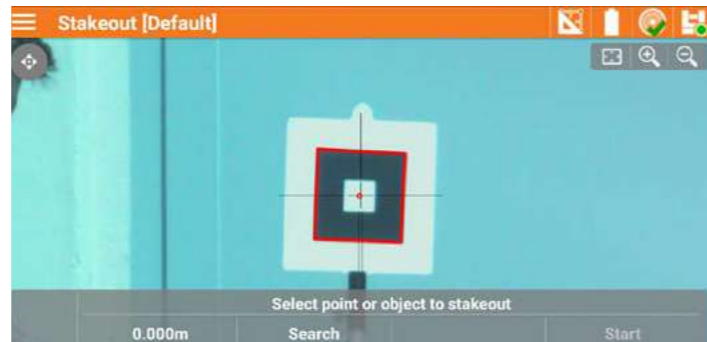

AUTOMATIC LINE AND SURFACE SCANS

When geometry becomes complex and surfaces are curved, Zoom3D measures horizontal, vertical and sloped sections automatically.

TECHNICAL DATA

Goniometer (Hz/V) range and accuracy	Horizontal 360°; Vertical 250°; 5", equates to 1.2mm @ 50m
Laser distance meter	Coaxial, visible red laser; Class 2; 650nm; < 1mW
Range	0.5 - 50m
Vertical/Horizontal field of view	Angle and distance combination @10m/1mm; @30m/2mm; @50m/4mm
Tilt sensor self-levelling range	± 3°



GEOMAX LEVELS

GeoMax levels make it easy to complete your daily levelling tasks on time with the highest accuracy. Rely on their comfort and robustness when working indoor or outdoor, even under challenging weather conditions.



GeoMax ZDL700 Series

A digital level offering accurate results and fast operation



QUICK, EASY AND ERROR-FREE

The three-seconds measurement speed in combination with the simplicity of the one-push measure-and-store functionality allows fast and easy workflows.

LEAVE THE CALCULATOR IN YOUR POCKET

Execute all kind of calculations with GeoMax ZDL700. It is equipped with an on board adjustment program, height difference calculations, an inverse staff measuring mode, and various measuring configurations. Thanks to digital readings and automated calculation, you will never again be slowed down by time-consuming calculator usage.

ACCURATE

Extensive field tests verify the excellent accuracy of the ZDL700 of 0.7mm for 1km double-run level. This makes the ZDL700 an ideal level not only for high performance levelling but also deformation measurements and precise surveying, as well as general construction.

TECHNICAL DATA	
Height accuracy	± 0.7mm/km double run
Distance accuracy	D < 10m, 10mm D ≥ 10m, 0.001 x D
Maximum range	105m
Single measurement speed	< 3 seconds
Internal memory	2,000 measurements



GeoMax ZAL Serie

Automatic levels covering from beginner to expert



Intensify your performance and get error-free results at the best price-to-performance ratio.

The GeoMax ZAL Automatic Level series are dependable and durable tools. Available for all skill levels, GeoMax levels enable all construction professionals to work correctly and economically.

With different types of magnification, a new ergonomic and solid-built design, and full range of accessories and services, these automatic levels provide great quality at affordable value.



GeoMax ZAL300 Series
Professional/high precision



GeoMax ZAL200 Series
Professional/standard tasks



GeoMax ZAL100 Series
Economic choice/occasional use

TECHNICAL DATA	ZAL330	ZAL328	ZAL324	ZAL320	ZAL232	ZAL224	ZAL220	ZAL132	ZAL124	ZAL120
Accuracy Standard deviation 1km double-run levelling	1.2mm	1.5mm	2.0mm	2.5mm	1.9mm	2.0mm	2.5mm	2.0mm	2.0mm	2.5mm
Image	Erect	Erect	Erect	Erect	Erect	Erect	Erect	Erect	Erect	Erect
Magnification	30 x	28 x	24 x	20 x	32 x	24 x	20 x	32 x	24 x	20 x
Shortest target distance from instrument axis	0.8m	0.8m	0.6m	0.6m	1m	1m	1m	1m	1m	1m
Multiplication factor	100	100	100	100	100	100	100	100	100	100
Compensator working range/setting accuracy	± 15'/0.3"	± 15'/0.3"	± 15'/0.5"	± 15'/0.5"	± 15'/0.5"	± 15'/0.5"	± 15'/0.5"	± 15'/0.5"	± 15'/0.5"	± 15'/0.5"
Circular level sensitivity	10'/2mm	10'/2mm	10'/2mm	10'/2mm	8'/2mm	8'/2mm	8'/2mm	8'/2mm	8'/2mm	8'/2mm
Protection	IP57	IP57	IP57	IP57	IP56	IP56	IP56	IP54	IP54	IP54

GEOMAX LASER ROTATORS

Suitable for a wide range of applications, GeoMax laser rotators are true multi-purpose tools.



GeoMax Zone Series

From start to finish, covering every need

Construction sites can differ drastically, from modest jobs to compound designs. Construction professionals need a tool with extensive range and capabilities to finish the job correctly and economically. The new and powerful GeoMax laser rotators portfolio offers the right construction tools for all trades and applications.

Solidly built and dependable in any element, the GeoMax lasers provide you long-lasting operation from multiple charging options, the flexibility of a full range of interchangeable accessories to accommodate your unique work preference, and all at the best price-to-performance ratio.

IP68/67 PROTECTION

OUTSTANDING PRICE-TO-PERFORMANCE RATIO

DEPENDABLE IN ANY ELEMENT

INTERCHANGEABLE ACCESSORIES

SOLID-BUILT DESIGN

LONG-LASTING OPERATION

3/5 YEARS WARRANTY

ERROR-FREE RESULTS

GeoMax Zone60 DG

Fully-automatic dual grade laser

TECHNICAL DATA	
Functionality	Self-levelling horizontal, vertical, digital slope in dual axis (full-automatic), Beam catch and Lock function
Operating range (diameter)	900m/3000ft
Self-levelling accuracy	± 1.5mm at 30m (±1/16" at 100ft)
Self-levelling range	± 5°
Grade range	Up to 15%
Rotation speed	300, 600rpm
Laser diode type/class	635nm (visible)/class 1
Batteries type	Li-Ion
Battery life	> 40h
Operating temperature	-20°C to 50°C
Protection	IP67
Warranty	5 years

Fully-automatic grade laser specifically designed for construction workers who need the dependability and accuracy of a fully professional grade laser rotator on a daily basis. Align and monitor the laser plane automatically by using the GeoMax ZRD105B receiver.



GeoMax Zone60 HG

Semi-automatic grade laser

Zone60 HG is made for exterior applications and is an ideal partner for concrete as well as formwork. With the slope function, time and temperature changes are frequently monitored to ensure accurate performance.



TECHNICAL DATA	
Functionality	Self-levelling horizontal, digital slope in dual axis (semi-automatic)
Operating range (diameter)	900m/3000ft
Self-levelling accuracy	± 1.5mm at 30m (±1/16" at 100ft)
Self-levelling range	± 5°
Grade range	Up to 15%
Rotation speed	300, 600rpm
Laser diode type/class	635nm (visible)/class 1
Batteries type	Li-Ion
Battery life	> 40h
Operating temperature	-20°C to 50°C
Protection	IP67
Warranty	3 years

GeoMax Zone20 H

Automatic entry-level laser rotator

Economic and firm entry-level laser rotator, the GeoMax Zone20 H is designed with a solid-built housing and a straightforward interface. This laser offers all functions needed for regular and flexible use.



TECHNICAL DATA	
Functionality	Self-levelling horizontal, manual slope in dual axis
Operating range (diameter)	900m/3000ft
Self-levelling accuracy	±2.2mm at 30m (± 3/32" at 100ft)
Self-levelling range	±5°
Grade range	-
Rotation speed	600rpm
Laser diode type/class	635nm (visible)/class 1
Batteries type	Li-Ion
Battery life	> 40h
Operating temperature	-10°C to 50°C
Protection	IP67
Warranty	3 years

GeoMax Zone40 H

Best construction site laser rotator

Are you looking for performance and absolute dependability? GeoMax Zone40 H is the best construction site laser for rough environments. Combining solid-built housing with a powerful

dependable core, this laser is a long-term companion of choice for any heavy-duty levelling task.

TECHNICAL DATA	
Functionality	Self-levelling horizontal, manual slope in dual axis,
Operating range (diameter)	900m/3000ft
Self-levelling accuracy	± 1.5mm at 30m (±1/16" at 100ft)
Self-levelling range	± 5°
Grade range	-
Rotation speed	600rpm
Laser diode type/class	635nm (visible)/class 1
Batteries type	Li-Ion
Battery life	> 40h
Operating temperature	-10°C to 50°C
Protection	IP67
Warranty	5 years



GeoMax Zone20 HV

Automatic multipurpose laser rotator



This laser offers the Zone20 H basic specifications plus the capability of vertical levelling. Zone20 HV includes a long-range remote to adjust and align easily in any jobsite. The multipurpose laser for any craftsman.

TECHNICAL DATA	
Functionality	Self-levelling horizontal, vertical, 90° manual slope in dual axis
Operating range (diameter)	900m/3000ft
Self-levelling accuracy	±2.2mm at 30m (±3/32" at 100ft)
Self-levelling range	±5°
Grade range	-
Rotation speed	120, 300, 600rpm
Scanning modes	10° - 35°
Laser diode type/class	635nm (visible)/class 2
Batteries type	Li-Ion
Battery life	> 40h
Operating temperature	-10°C to 50°C
Protection	IP67
Warranty	3 years

GEOMAX PIPE LASERS

Consistent precision and accuracy are ensured by the compact, robust and fully featured GeoMax pipe lasers.



GeoMax Zeta125 Series

Versatile configuration, a full range of features, and a tough design

BUILT TO LAST

The robust and rugged design of the Zeta series has a proven IP rating for water and dust – so no matter how quickly water and dirt appear, the pipe laser will keep on working. The Zeta series are also equipped with a durable cast-aluminium housing that uses die casts and extrusions for superior strength.

ERROR-FREE WORK

Pipelining needs to be exact over long distances so with a guarantee of ±10 arc sec. accuracy during levelling works and a grade setting control of up to 0.001 per cent, Zeta pipe lasers let you work close to error-free.

In addition to the accurate levelling core, Zeta125s model features active cross axis compensation for any possible setup mistake.

SELF-LEVELLING

Set the pipe grade from -10 per cent to +40 per cent.

VERSATILE CONFIGURATION

The GeoMax Zeta125 fits in tight bends and narrow manholes. Its slim build makes it suitable for pipes as small as 125mm diameter and the Zeta feet ensure users continue working in most any site situation.

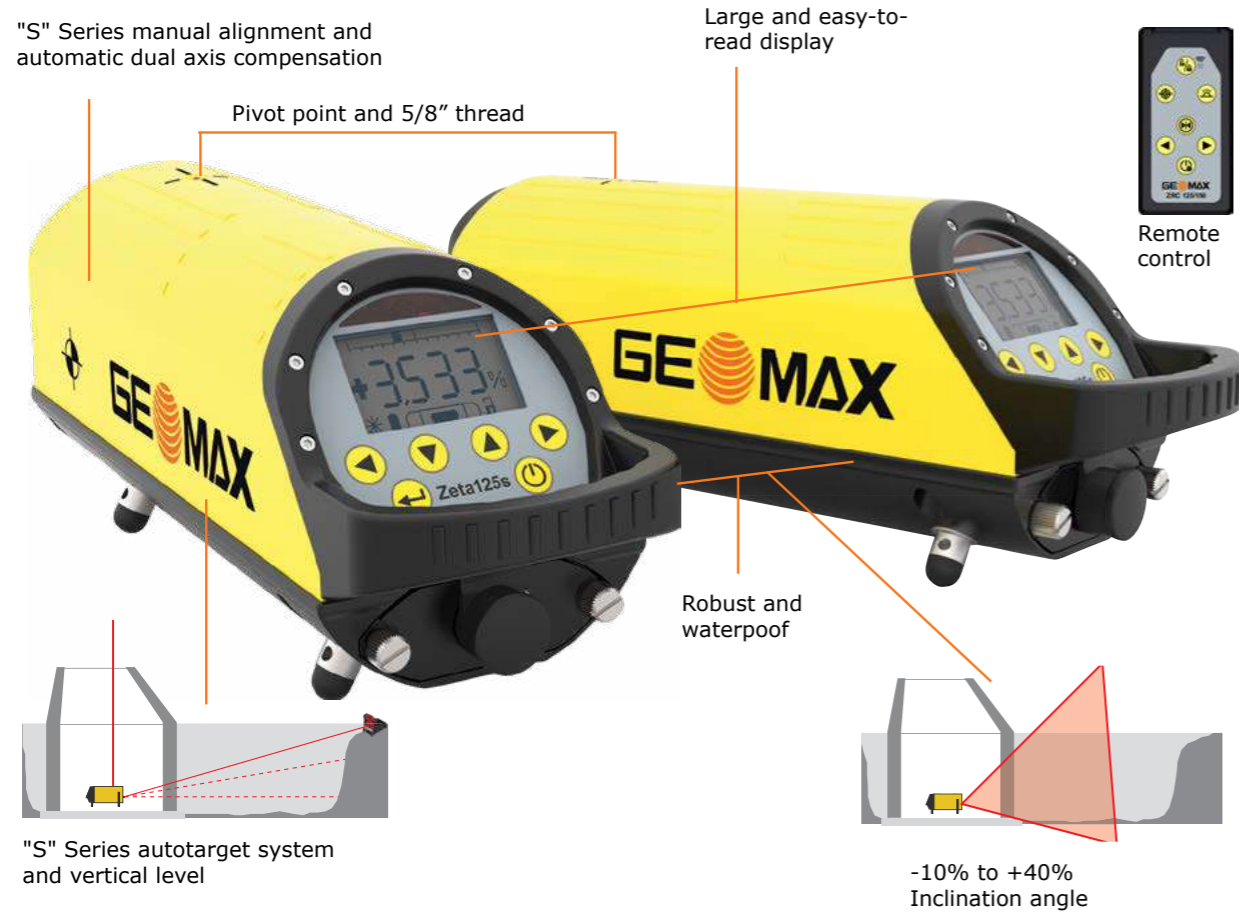

THE SMALLEST DIAMETER

The Zeta125 fits in tight bends and narrow manholes. Due to its slim housing, it is suitable for pipes with 125mm (5") diameter. Thanks to its weight and the rubber feet, Zeta laser series have a stable stand on any pipe material.



TECHNICAL DATA	ZETA125	ZETA125 US	ZETA125S
Self-levelling/grade range	+45% to -15%/+40% to -10%		
Accuracy	±5mm at 100m (± 1/16" at 100'); ± 10 arc sec.; ± .005%		
Cross axis levelling	Manual		Automatic (6°)
Vertical level/Autotarget/Manual alignment	-	-	✓
Laser Class	2	3R	3R
Protection class	IP68		
Power supply/battery life	Rechargeable lithium ion battery pack; 110/230V AC converter (charge and run simultaneously); 12V power cord/40h Li-Ion battery		

GEOMAX MACHINE GUIDANCE

No more intuitive guesswork or costly and difficult-to-install-and-operate machine control systems. GeoMax has an easy and accurate way to guide excavators.



GeoMax EzDig Series

The easy and accurate way to guide excavators

The GeoMax EzDig S and T excavator guidance systems offer the easiest calibration and equipment operation available on the market at an affordable price. The EzDig excavator guidance systems "work when you do!"

BENEFITS

- No more overcutting, costly fill materials and rework
- Eliminate checking and installation machine downtime
- No more time-consuming tape measurements
- Save fuel, time and material

TECHNICAL DATA	EZDIG STANDARD	EZDIG TOUCH
System power	12/28V	
Angle sensor Battery charger Dimension and weight Protection	Solar 70x100x20mm; 282g IP67 Water and dust	
Control unit Screen size and resolution	Digital 2.6" (10cm) 128x64 pixels	Touch 7" (18cm) 800x480 pixels
Optional 2D sensor	N/A	2D Gyro sensor
Memory Machines/Buckets number	5/10 per machine	over 100/over 100
Accuracy	+/- 7/16" - 1cm	
Operating temperature	-20° to + 70° (-4° to 158° F)	

Touch control unit

Calibration storage 100 machines/10,000 buckets

Optional 2D sensor

Intuitive graphic representation

7" colour and touch screen

Functions at your fingertips

Video integration for help and FAQs



Standard control unit

5 machines/150 buckets calibration storage

Rugged and compact design

One-function buttons for fast access to all functions

Easy-to-understand and functional icons



LED display

Easy level indication

Magnetic holder

Heads-up and transparent device

High brightness sunlight readable LED display

Wireless antenna for sensors

Screw-free installation with suction cap

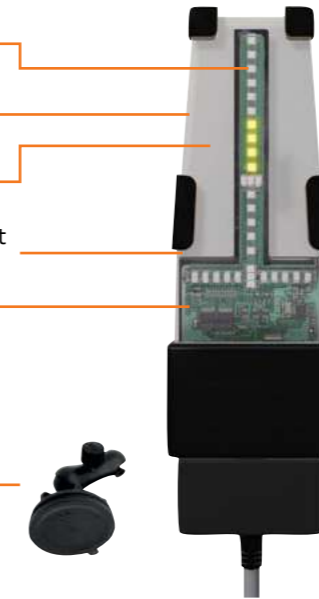

Sensors

Sensor plates mounting via 3M extra strong adhesive tape, no welding necessary

Laser catcher for optional reference to laser rotator

Self-calibrating high precision angle sensor

Solar powered and charged sensors with low cost holders to apply on multiple machines

Wireless communication to controller

2D sensor for working 360° in field with single or double slope and no limits of straight line



REAL-TIME INDICATION

Depth

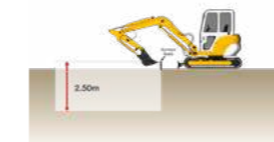

Slope



Distance

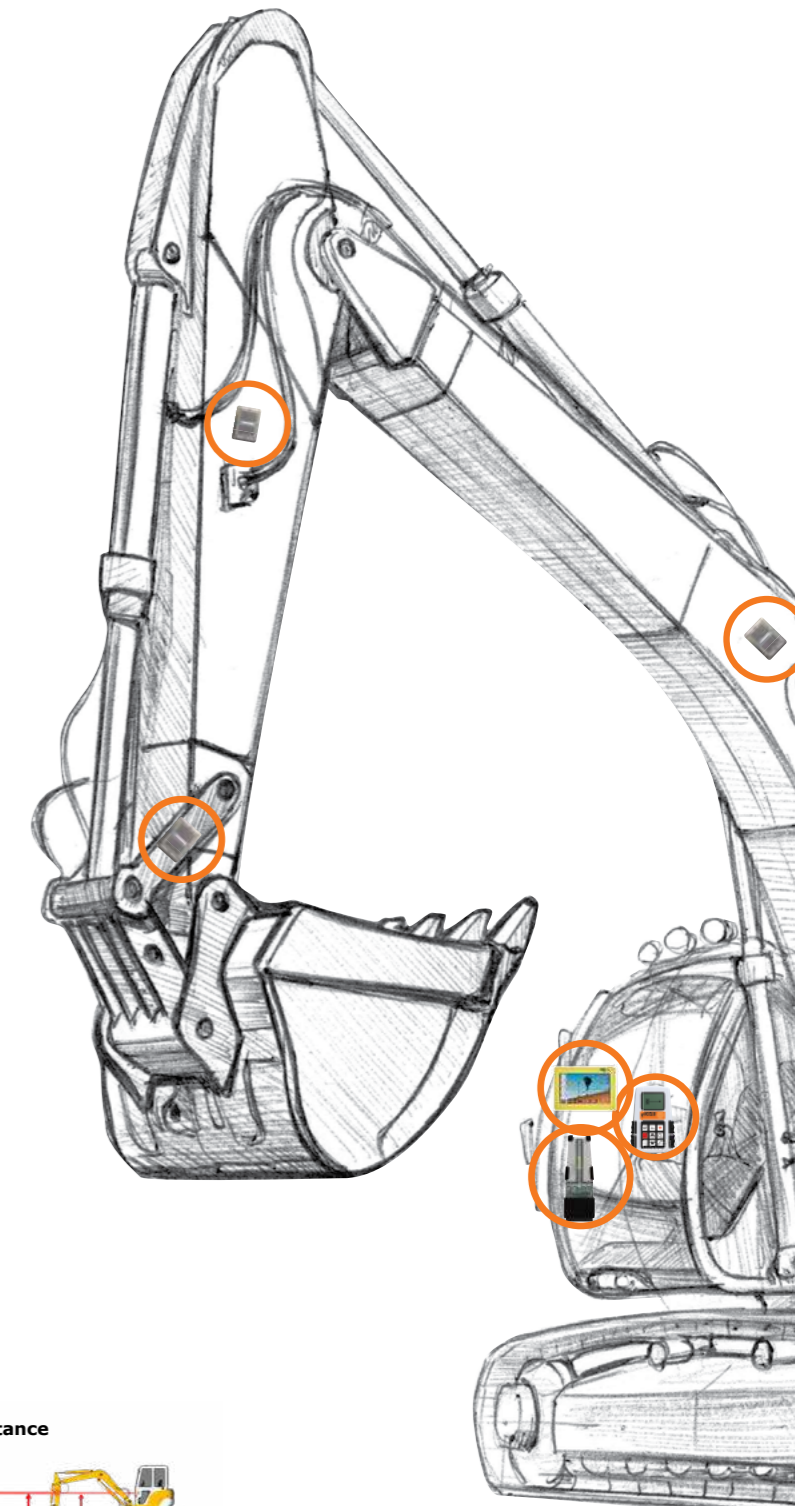
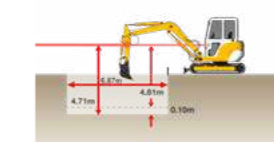

GeoMax MR240

Ideal for use with backhoes and mini-excavators

The GeoMax MR240's LED indicators show the position of cutting edge in relation to laser reference beam. The MR240 has three indicators in coarse mode, up to five in fine mode and is equipped with magnet mount with extra strong rare earth magnets.

- Accurate grade information for all visual machine control applications
- Extra strong rare earth magnets
- Rugged and waterproof design

TECHNICAL DATA	
Range	200m
Accuracy	Fine 6mm Coarse 30mm
Reception angle	240°
Reception height	14cm
Power	3 x AA batteries, 1,5V
Battery life	130h
IP protection	IP67
Weight w/o battery	2.2kg
Size	220x120x100mm

GeoMax MR360R

Accurate grade information for all visual machine control applications

The GeoMax MR360R's large 360° detection windows pick up any rotating laser from any angle. The MR360R incorporates a built-in vertical indicator that monitors angle of the stick, signalling of the stick and signals if it is plumb or under/over extended. The remote display shows direction arrows for plumbing up the dipper stick.

Its receiver has plumb LED indicator, and its magnet mount allows quick setup and easy movement from machine to machine.

Clamp mount also available.

- 360° detection windows for total coverage
- In-cabin remote display for best control
- On operations
- No cables required

TECHNICAL DATA	
Range	200m
Accuracy	Fine 6mm Coarse 12mm
Reception angle	360°
Reception height	25cm
Power	NiMh rechargeable batteries
Battery life	130h
IP protection	IP67
Weight w/o battery	1.8kg
Size	375"x75x107mm



GEOMAX CABLE LOCATORS

Increase on-site safety, minimise human error, and save time and money.





GeoMax EziSystem

Increase safety, decrease costs

Every year many site workers are injured and equipment is damaged due to accidentally striking buried cables and pipes. As the complexity of large underground networks continually increases, knowing the location of buried cables and pipes prior to excavation work has never been so important.



EZISYSTEM I-SERIES

Easily avoid buried cables and pipes before excavation work

The EZISYSTEM cable avoidance equipment makes locating buried cables and pipes easy and efficient. With an EZiCAT i-Series locator, there is no need to manually adjust the sensitivity. With the unique Automatic Pinpointing feature, users can simply press the trigger and start locating.



EZISYSTEM XF-SERIES

Easily locate and trace buried utilities over greater distances

The EZISYSTEM xf-Series utility locating and tracing equipment makes locating buried utilities easy and efficient. The xf-Series locators have additional low frequencies enabling you to locate and trace utilities over longer distances and in congested environments.



BENEFITS OF DATA LOGGING IN 5 STEPS

- Conduct ground survey gathering data
- Send logged data to Bluetooth® enabled PC
- View EZiCAT usage statistics and charts
- Make informed decisions to efficiently manage EZiCAT fleet and operators
- Implement changes to procedures for better results

A collection of colorful hard hats (yellow, white, green, blue) is arranged on a wooden surface. The blue hard hat in the foreground is the most prominent, showing its textured surface and ventilation slots. Other hats in various colors are visible in the background, slightly out of focus.

GEOMAX ACCESSORIES & QUALITY MANAGEMENT

GeoMax equipment is built with the intention to withstand all conditions you run into during your daily work.

GeoMax Accessories

GeoMax accessories have been individually tested to provide you the best performance and reliability during all your daily tasks. You can be assured that the complete range of GeoMax accessories is of quality that meets the highest demands and

simply "works when you do." This is a selection of our current accessories portfolio. Ask your local GeoMax representative for additional options.



ZTW100

- Wooden tripod
- shoulder strap and side clamp screws
- packaged length 104cm extended length to 166cm
- weight 5.7kg



ZTA100

- Aluminium light weight tripod
- shoulder strap and side clamp screws
- packaged length 105cm extended length 167cm
- weight 4.5kg



CT160

- Aluminium tripod
- shoulder strap and screws
- Range from 103cm up to 167cm
- medium weight



ZCA102

- Reflector carrier
- tubular level
- optical plummet for precise positioning



ZCA100

Tribrach carrier for GNSS antennas.



ZCA101

Tribrach carrier with stub for prisms.



ZPC200

- Telescopic carbon fibre
- aluminium pole for GNSS
- Extends to 230cm



ZPC201

- Telescopic carbon fibre
- aluminium pole for TPS
- Extends to 230cm



ZPC202

- GNSS pole
- length 25cm
- for mounting Zenith receiver on carrier as extension for base setups



ZST100

- Telescopic
- dual-strut pole support
- Suitable for all GeoMax poles and level staffs



ZPT4

- Mini TPS pole
- four screwable segments
- Extends to 30cm
- with a pin

TOTAL STATION, CONTROLLER & DIGITAL LEVEL CABLES

Zipp10 Pro/Zoom40	USB	Cable mini-USB to USB host connecting to a PC/tablet	ZDC301
Zoom25/50	USB	Cable Lemo-USB connecting to a PC/tablet using USB transfer technology	ZDC217
ZDL700	USB	Cable: Lemo-USB connecting ZTS600 & ZDL700 to PC/tablet	ZDC102
GNSS CABLES			
ZENITH15/25 PRO	RS232	Cable Lemo-RS232 connecting to a PC/tablet	ZDC227
	USB	Cable Lemo-USB connecting to a PC/tablet	ZDC226
ZENITH35 PRO	Satel EA-SyPro/battery	Y-Cable Lemo to Lemo and clamps connecting with Satel EASyPro radio and external battery for power supply	ZDC225
	USB/RS232	Y-Cable Lemo to USB and RS232 for Zenith35	ZDC509
	Satel EA-SyPro/battery	Y-Cable Lemo to Lemo and clamps connecting with Satel EASyPro radio and external battery for power supply.	ZDC221

GeoMax Accessories



ZRP1
360° prism with soft bag.



GRZ122
360° prism with 5/8" for GNSS antenna.



ZMP100

- Mini prism 0-constant with tip
- fits to ZPC105 pole



ZPR100 AND ZTP100

- Circular prism with red holder 0-offset
- ZTP100 target plate for precise aiming over long distances is separately available



ZTR101
Standard tribrach without optical plummet.

ZTR103
Standard tribrach with optical plummet.

ZTR201
Advanced tribrach without optical plummet.



ZMP101
Mini prism with tip.

GSS111

- Four-section telescopic staff
- Provides dual measuring faces
- bar code and millimetre graduations

GSS113

- Dual face high accuracy fibreglass levelling staff
- length 3m
- 1 section
- barcode/E-Scale cm-graduation
- circular bubble and handle

CLR102

- Level staff 5m
- 4 sections
- front side with E-graduation
- back side with mm-graduation

FLEXI ROD

- Laser level staff with a mm-scale on front side
- clamp for slide adapter, with bubble

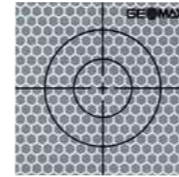

ZTM100

- Self-adhesive reflective target 6x6cm
- For measurement of surfaces standard EDM



LI-ION BATTERIES

- ZBA301 for Zipp10 Pro/Zoom40 total stations, 4.4Ah
- ZBA201 for Zoom total stations and Zenith15/25 Pro GNSS, 2.6Ah
- ZBA400 for Zoom total stations, 4.4Ah
- ZBA601 for Zenith35 Pro GNSS, 3.4Ah
- ZBA700 for Zenius5, 3.4Ah
- ZBA210 for Zenius8, 5.2Ah



ZDE100/GFZ4
Diagonal eyepiece.



ZST101
Tripod-star, for setting up of tripods on hard and slippery surfaces.

CHARGERS

- ZCH201 charger for ZBA201/400
- ZCH301 charger for ZBA301
- ZCH601 charger for ZBA601
- ZCH700 dual charger for ZBA700

GeoMax Accessories

LASER RECEIVERS

The GeoMax Zone Series comes with four laser receivers that will complement and boost your performance.



	ZRB90 BASIC	ZRP105 PRO	ZRD105 DIGITAL	ZRD105B
Working diameter	600m/2000ft	900m/3000ft	900m/3000ft	900m/3000ft
Detection window	80mm/3.1in	35mm/1.5in	105mm/4in	105mm/4in
Numeric readout height	-	-	90mm/3.5in	90mm/3.5in
Beam catching	-	-	-	✓
Beam lock	-	-	-	✓



ZCB100
Backstrap for hard shell containers.



ZCT102
Hard shell container for two circular prisms, two carriers, two tribrachs.



MW24

- Easy-to-use and light road measuring wheel
- handle activated wheel brake

GeoMax Quality Management



BUILT FOR ALL ENVIRONMENTS

With the design criteria "works when you do," GeoMax products are built to withstand all environmental conditions. GeoMax equipment is built with the intention to withstand all conditions you run into during your daily work. Rain, hail, snow or intense heat will never affect your GeoMax equipment - you can always keep working to get the job done.

OUR COMMITMENT TO SAFETY AND THE ENVIRONMENT

All GeoMax products are fully CE (Conformité Européenne) as well as RoHS (Restriction of the use of certain hazardous substances in electrical and electronic equipment) and WEEE (Waste from Electrical and Electronic Equipment) conformant.

OUR COMMITMENT TO QUALITY

The internationally active Swiss Association for Quality and Management Systems SQS, as well as the International Certification Network IQNET certified that GeoMax AG meets the requirements of ISO9001, Quality Management System and ISO14001, Environmental Management System.

- Certified area: Whole company.
- Field of activity: Development, manufacture, distribute, support and service of products, precision tools and systems for geomatic, industrial and construction applications.

Distance meter (Reflector mode): Laser class 1 in accordance with IEC 60825-1 resp. EN 60825-1
 Laser plummet: Laser class 2 in accordance with IEC 60825-1 resp. EN 60825-1
 Distance meter (Reflectorless mode accXess™): Laser class 3R in accordance with IEC 60825-1 resp. EN 60825-1

Windows® CE, Windows® 7, Windows® Embedded, and Windows® Mobile are registered trademarks of Microsoft Corporation.
 The Bluetooth® word mark and logos are owned by Bluetooth SIG.
 NovAtel On board® is a registered trademark of NovAtel Inc.
 Other trademarks and trade names are those of their respective owners.

GeoMax Selection of our portfolio:



X-PAD Ultimate



Total Stations



GNSS



Laser Rotators



Locators



Zoom3D



Zeta125 Series



Zenius5



Digital level

GEOMAX AUTHORISED DISTRIBUTION PARTNER

09/18/768325 en Copyright GeoMax AG.
Illustrations, descriptions and technical specifications are not binding and may change. All trademarks and trade names are property of their respective owners.